

UPDATE ON DECKS

2015 Minnesota Residential Code

Metro West Inspections

763-479-1720

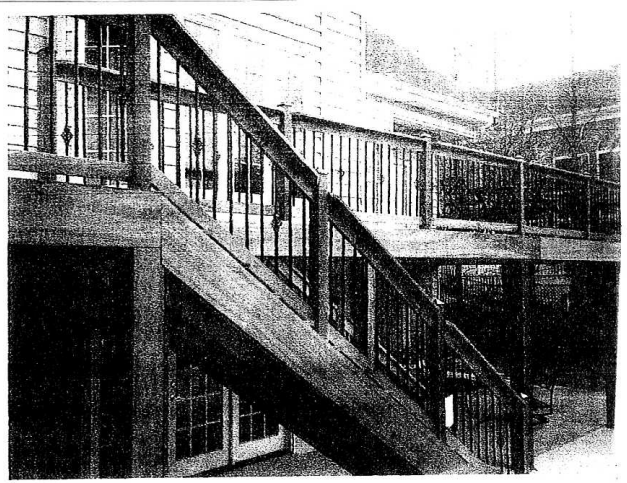

The focus of this handout is on new rules for the construction of decks and highlights a few common problem areas. Landowners and / or builders are responsible to comply with the 2015 Minnesota Residential Code (MRC) and local zoning laws. Contact your city hall to find out the minimum setbacks from property lines and easements, etc.

PERMITS:

A building permit is required for decks, with one exception: freestanding decks, if they are no more than 30 inches above the adjacent grade.

PLANS:

To apply for a building permit, submit four things to your city hall:

1. A completed application (available at city hall). Ask them when fees are due.
2. A lot survey or Site Plan showing the property, building/s and proposed deck.
3. A Plan View drawing of the deck.
4. A Section View drawing of the deck.

The plans identified in # 3 and # 4, above, should illustrate every material, spacing, detail and dimension of your proposed deck, from bottom of footing to top of guardrail. It must be drawn in a scale such as 1/4" = 1", or larger. [You may use the blank page of graph paper that follows.]

After the plans are reviewed and a permit is issued, you will receive the building permit, an "Inspection Record Card" on heavy stock and one set of approved plans, signed by our office. Check the plans to see if any changes or corrections have been noted, before beginning work.

BEFORE YOU DIG:

Call "Gopher State One Call" for utility locations at least **two days** before you dig.

651-454-0002 or 1-800-252-1166



3-26-2015

1.

INSPECTIONS:

Call **24 hours (or more)** before you want a building inspector on site: 763-479-1720

MATERIALS:

Fasteners

Nails and other hardware must be hot-dipped zinc-coated (galvanized), stainless steel or equal. Screws should be either hot-dipped galvanized or electroplated with a polymer coating. 12d nails are recommended on nominal 2-inch decking. 10d nails are recommended for 5/4" decking.

With lag screws, use a flat washer under the head. Use washers under the nut and head of machine bolts and just under the nut of carriage bolts.

Lumber

All wood used in deck construction must be pressure treated lumber or wood that is naturally resistant to decay such as redwood or cedar.

Wood used above ground, in contact with the ground, or below ground requires different degrees of treatment. Check the labels of the material you are buying to determine where it can be used.

Because some preservative treatments are very corrosive, make sure that any fasteners or metal connectors used in the construction of your deck are approved by the manufacturer for use with treated wood.

Decking

Materials commonly used for decking include standard dimension lumber (either 2X4 or 2X6), radius-edged decking, or a manufactured decking product.

Radius-edged Patio Decking (5/4 decking) has been specifically developed for outdoor decks.

Redwood and cedar patio decking is intended to be used flat-wise in load-bearing applications where spans do not exceed 16" o.c. (12" o.c. when installed diagonally to joists). Southern pine decking may span 24" o.c. or 16" o.c. when installed diagonally to joists.

Manufactured decking products may be used only when approved by the Building Department. This approval is based on the material carrying an NER or similar report. Decking without a research report will not be approved. Ask the decking supplier to provide you with a copy of the research report. The Building Department maintains a list of composite decking materials that meet US building codes that is available upon request. ***Caution – some manufactured deck products are approved for decking but not for stair treads. In some cases where manufactured decking is approved for stairs, the spacing of supports may be significantly reduced compared to use on the deck itself. Read the research report for further information.***

JOISTS:

JOIST SIZE	SOUTHERN PINE			WESTERN CEDAR/PONDEROSA PINE		
	12" oc	16" oc	24" oc	12" oc	16" oc	24" oc
2X6	10'4"	9'5"	7'10"	8'10"	8'0"	7'0"
2X8	13'8"	12'5"	10'2"	11'8"	10'7"	8'8"
2X10	17'5"	15'10"	13'5"	14'11"	13'0"	10'7"
2X12	21'2"	18'10"	15'5"	17'5"	15'1"	12'4"

NEW CODE: 2015 MRC Section 507

[Primary changes involve "Attachment of deck to home" and "Lateral Bracing".]

Minimum 1/2" lags, bolts or equal.

R506.2.4 Reinforcement support. Where provided in slabs on ground, reinforcement shall be supported to remain in place from the center to upper one third of the slab for the duration of the concrete placement.

or approved decay-resistant species, and a 2-inch (51 mm) nominal lumber band joist bearing on a sill plate or wall plate shall be constructed with 1/2-inch (12.7 mm) lag screws or bolts with washers in accordance with Table R507.2. Lag screws, bolts and washers shall be hot-dipped galvanized or stainless steel.

SECTION R507 DECKS

**

R507.1 Decks. Where supported by attachment to an exterior wall, decks shall be positively anchored to the primary structure and designed for both vertical and lateral loads. Such attachment shall not be accomplished by the use of toenails or nails subject to withdrawal. Where positive connection to the primary building structure cannot be verified during inspection, decks shall be self-supporting. For decks with cantilevered framing members, connections to exterior walls or other framing members, shall be designed and constructed to resist uplift resulting from the full live load specified in Table R301.5 acting on the cantilevered portion of the deck.

R507.2 Deck ledger connection to band joist. For decks supporting a total design load of 50 pounds per square foot (2394 Pa) [40 pounds per square foot (1915 Pa) live load plus 10 pounds per square foot (479 Pa) dead load], the connection between a deck ledger of pressure-preservative-treated Southern Pine, incised pressure-preservative-treated Hem-Fir

R507.2.1 Placement of lag screws or bolts in deck ledgers and band joists. The lag screws or bolts in deck ledgers and band joists shall be placed in accordance with Table R507.2.1 and Figures R507.2.1(1) and R507.2.1(2).

R507.2.2 Alternate deck ledger connections. Deck ledger connections not conforming to Table R507.2 shall be designed in accordance with accepted engineering practice. Girders supporting deck joists shall not be supported on deck ledgers or band joists. Deck ledgers shall not be supported on stone or masonry veneer.

R507.2.3 Deck lateral load connection. The lateral load connection required by Section R507.1 shall be permitted to be in accordance with Figure R507.2.3. Where the lateral load connection is provided in accordance with Figure 507.2.3, hold-down tension devices shall be installed in not less than two locations per deck, and each device shall have an allowable stress design capacity of not less than 1500 pounds (6672 N).

TABLE R507.2
FASTENER SPACING FOR A SOUTHERN PINE OR HEM-FIR DECK LEDGER AND
A 2-INCH-NOMINAL SOLID-SAWN SPRUCE-PINE-FIR BAND JOIST^{e, f, g}
(Deck live load = 40 psf, deck dead load = 10 psf)

JOIST SPAN	6' and less	6'1" to 8'	8'1" to 10'	10'1" to 12'	12'1" to 14'	14'1" to 16'	16'1" to 18'
Connection details	On-center spacing of fasteners^{d, a}						
1/2 inch diameter lag screw with 15/32 inch maximum sheathing ^a	30	23	18	15	13	11	10
1/2 inch diameter bolt with 15/32 inch maximum sheathing	36	36	34	29	24	21	19
1/2 inch diameter bolt with 15/32 inch maximum sheathing and 1/2 inch stacked washers ^{b, h}	36	36	29	24	21	18	16

For SI: 1 inch = 25.4 mm, 1 foot = 304.8 mm, 1 pound per square foot = 0.0479 kPa.

- a. The tip of the lag screw shall fully extend beyond the inside face of the band joist.
- b. The maximum gap between the face of the ledger board and face of the wall sheathing shall be 1/2 inch.
- c. Ledgers shall be flashed to prevent water from contacting the house band joist.
- d. Lag screws and bolts shall be staggered in accordance with Section R507.2.1.
- e. Deck ledger shall be minimum 2 x 8 pressure-preservative-treated No. 2 grade lumber, or other approved materials as established by standard engineering practice.
- f. When solid-sawn pressure-preservative-treated deck ledgers are attached to a minimum 1-inch-thick engineered wood product (structural composite lumber, laminated veneer lumber or wood structural panel band joist), the ledger attachment shall be designed in accordance with accepted engineering practice.
- g. A minimum 1 x 9/2 Douglas Fir laminated veneer lumber rimboard shall be permitted in lieu of the 2-inch nominal band joist.
- h. Wood structural panel sheathing, gypsum board sheathing or foam sheathing not exceeding 1 inch in thickness shall be permitted. The maximum distance between the face of the ledger board and the face of the band joist shall be 1 inch.

TABLE 507.2.1
PLACEMENT OF LAG SCREWS AND BOLTS IN DECK LEDGERS AND BAND JOISTS

	TOP EDGE	BOTTOM EDGE	ENDS	ROW SPACING
Ledger ^a	2 inches ^d	1/4 inch	2 inches ^b	1 5/8 inches ^b
Band Joist ^c	3/4 inch	2 inches	2 inches ^b	1 5/8 inches ^b

For SI: 1 inch = 25.4 mm.

- a. Lag screws or bolts shall be staggered from the top to the bottom along the horizontal run of the deck ledger in accordance with Figure R507.2.1(1).
- b. Maximum 5 inches.
- c. For engineered rim joists, the manufacturer's recommendations shall govern.
- d. The minimum distance from bottom row of lag screws or bolts to the top edge of the ledger shall be in accordance with Figure R507.2.1(1).

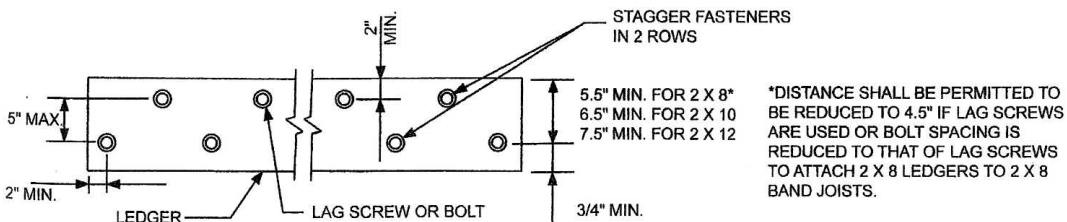

For SI: 1 inch = 25.4 mm.

FIGURE R507.2.1(1)
PLACEMENT OF LAG SCREWS AND BOLTS IN LEDGERS

R507.3 Wood/plastic composites. Wood/plastic composites used in exterior deck boards, stair treads, handrails and guardrail systems shall bear a label indicating the required performance levels and demonstrating compliance with the provisions of ASTM D 7032.

R507.3.1 Installation of wood/plastic composites. Wood/plastic composites shall be installed in accordance with the manufacturer's instructions.

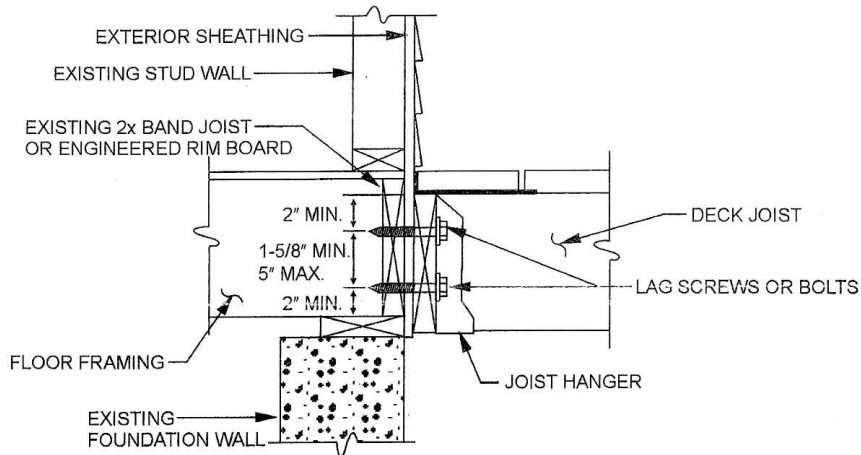

For SI: 1 inch = 25.4 mm.

FIGURE R507.2.1(2)
PLACEMENT OF LAG SCREWS AND BOLTS IN BAND JOISTS

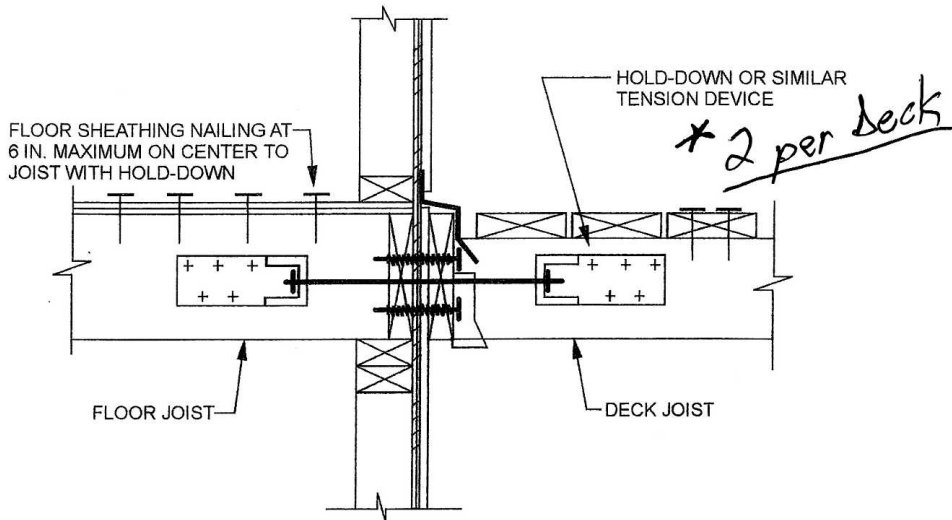

For SI: 1 inch = 25.4 mm.

FIGURE 507.2.3
DECK ATTACHMENT FOR LATERAL LOADS

CODE EQUIVALENTS:

Other means to comply with the Lateral Load bracing have been introduced by manufacturers, such as the Simpson DTT brackets (Deck Tension Ties). **Four of these per deck** would provide the required lateral bracing to a rim or band joist.

Load Table: See code report listings below

These products are available with additional corrosion protection. Additional products on this page may also be available with this option, check with Simpson Strong-Tie for details.

Model No.	C	Anchor Dia.	Fasteners	Minimum Wood Member Thickness	Allowable Tension Loads	
					DF/SP	SPF/HF
DTT1Z	1/2	5/8" or SDWH ¹	6-SD #9x1 1/2"	1 1/2	840	840
			6-10dx1 1/2"		910	640 ¹
			8-10dx1 1/2"		910	850
DTT2Z/DTT2SS	3/16	1/2	8-1/2"x1 1/2" SDS	1 1/2	1825	1800
				3	2145	1835
DTT2Z-SDS2.5	3/16	1/2	8-1/2"x2 1/2" SDS	3	2145	2105

¹ The allowable loads have been increased 60% for wind or earthquake loading with no further increase allowed. If the design does not satisfy the 2015 IRC requirements for deck-to-house latera

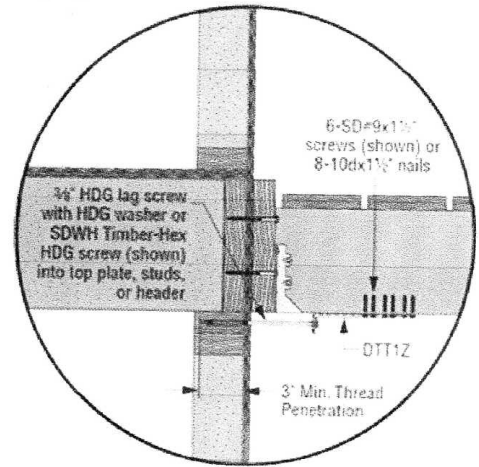
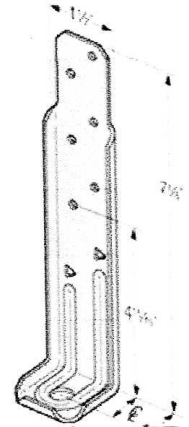

FLOOR TRUSSES:

(This is a suggested connection for a new deck ledger to a floor truss)

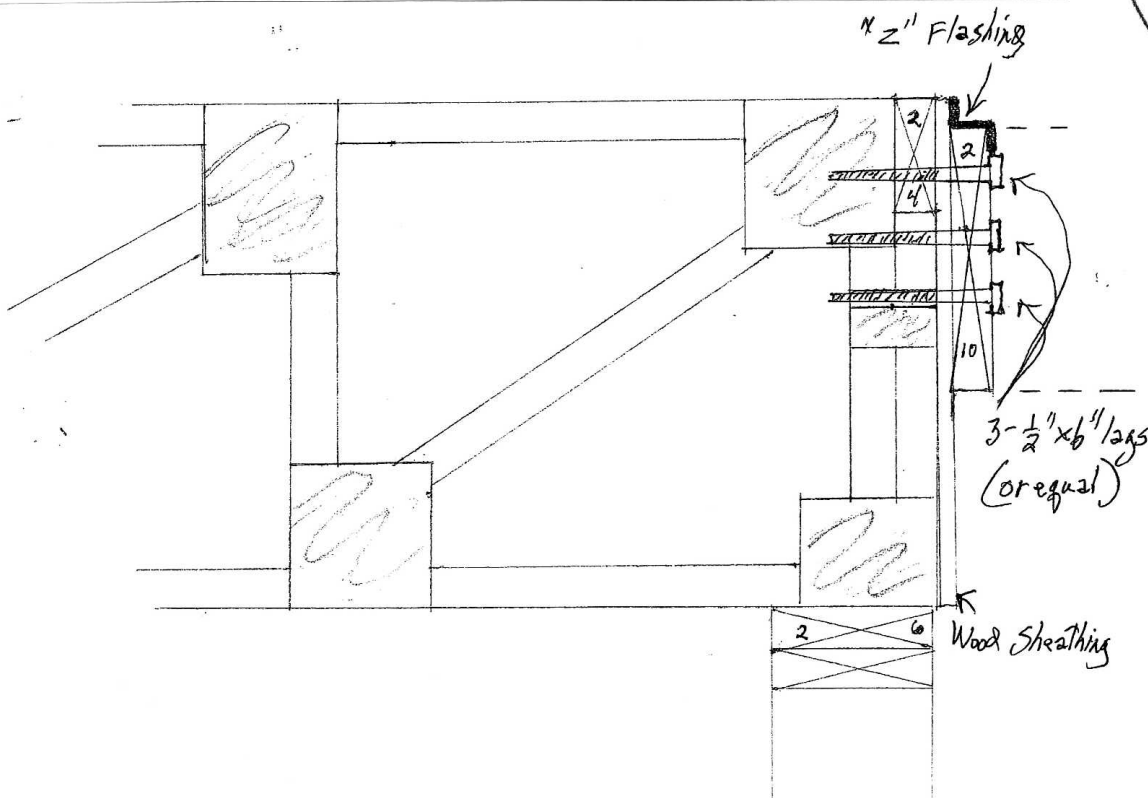

STAIRS / HANDRAILS / GUARDRAILS:

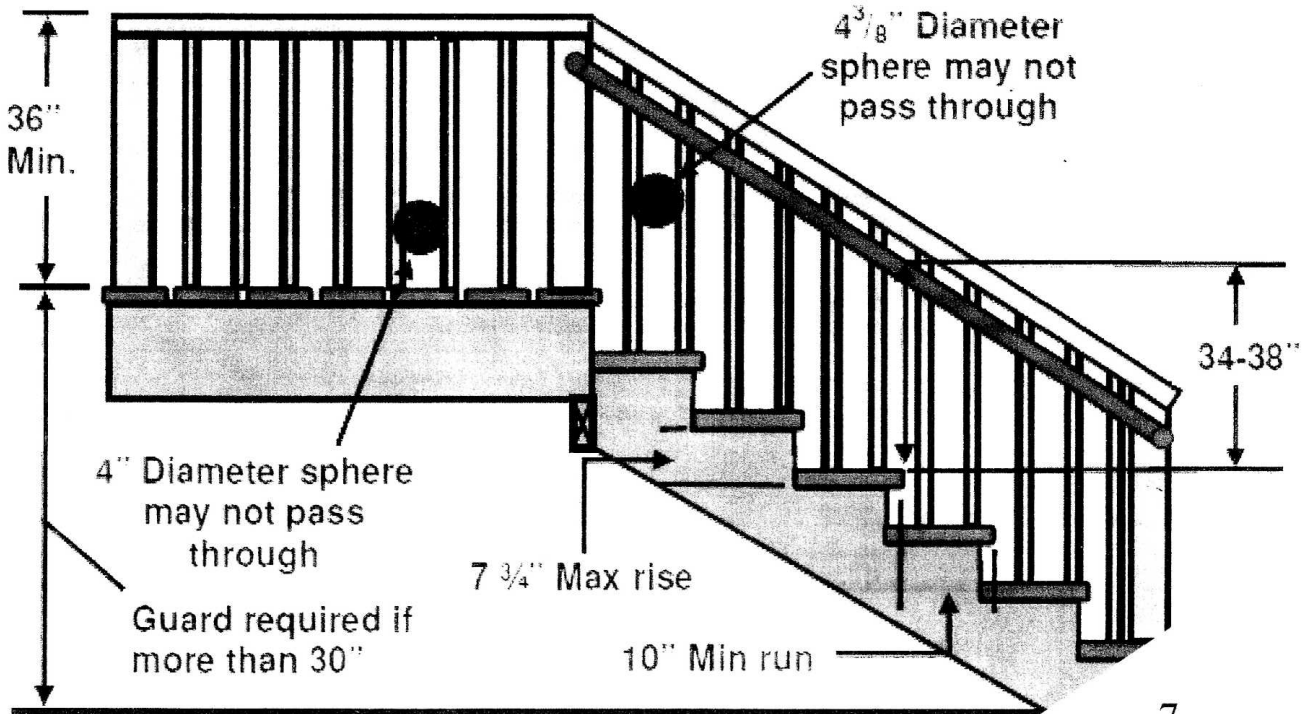
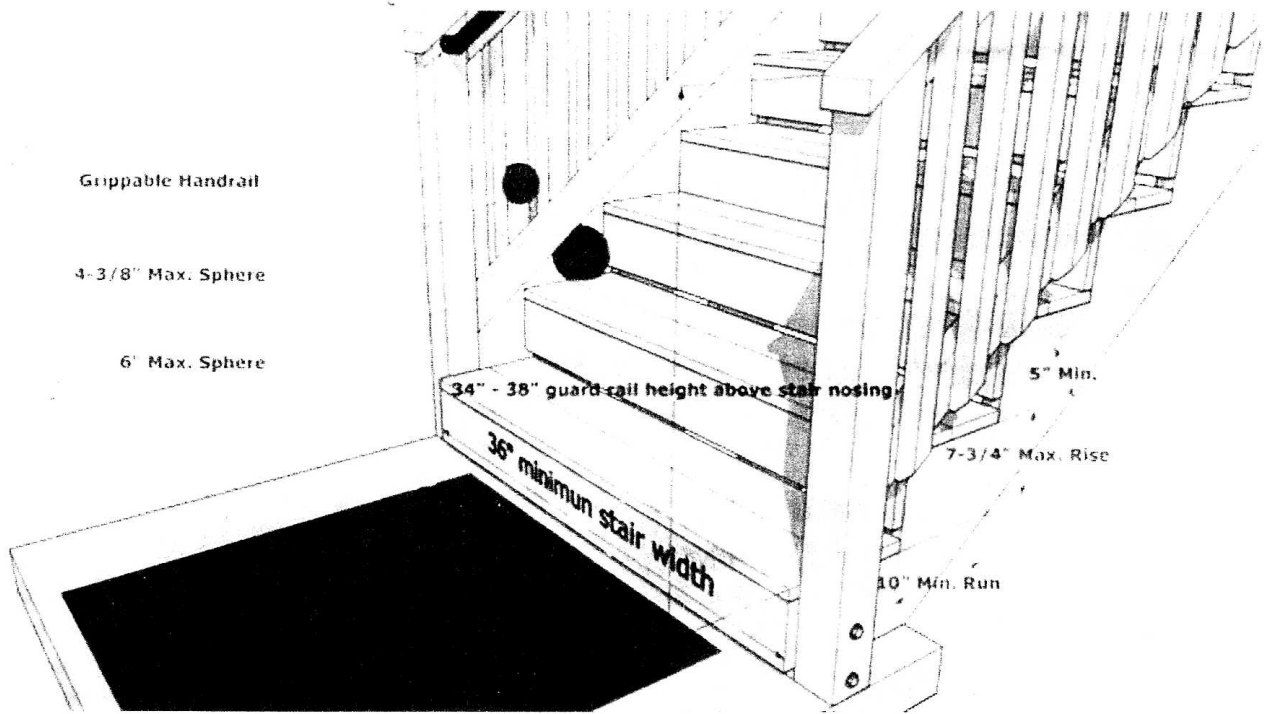

STAIR ATTACHMENTS

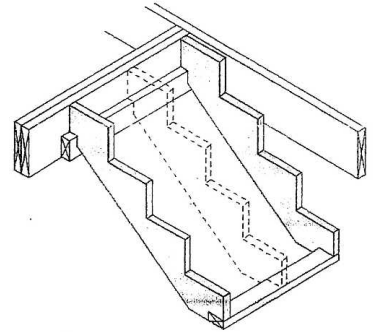
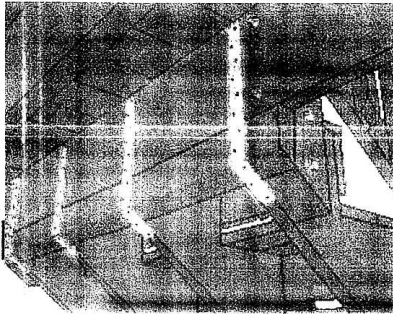
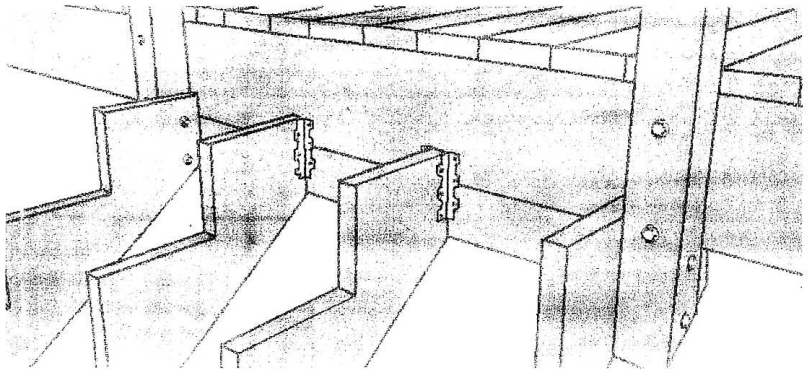
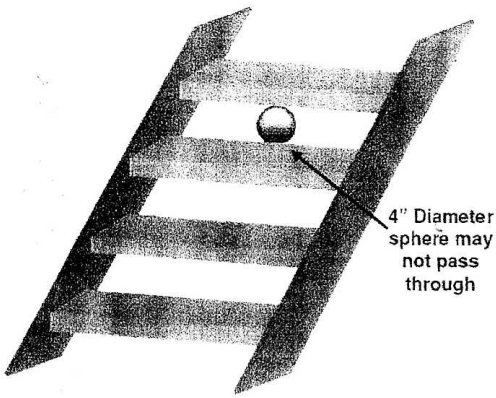

HANDRAIL RETURNS

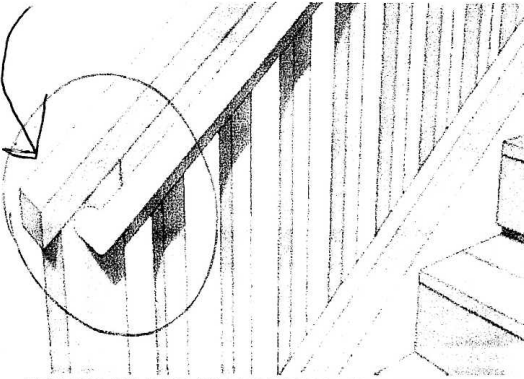

HANDRAILS MUST RETURN TO A NEWEL POST AND BE CONTINUOUS WITHOUT INTERRUPTION FOR THE LENGTH OF THE FLIGHT

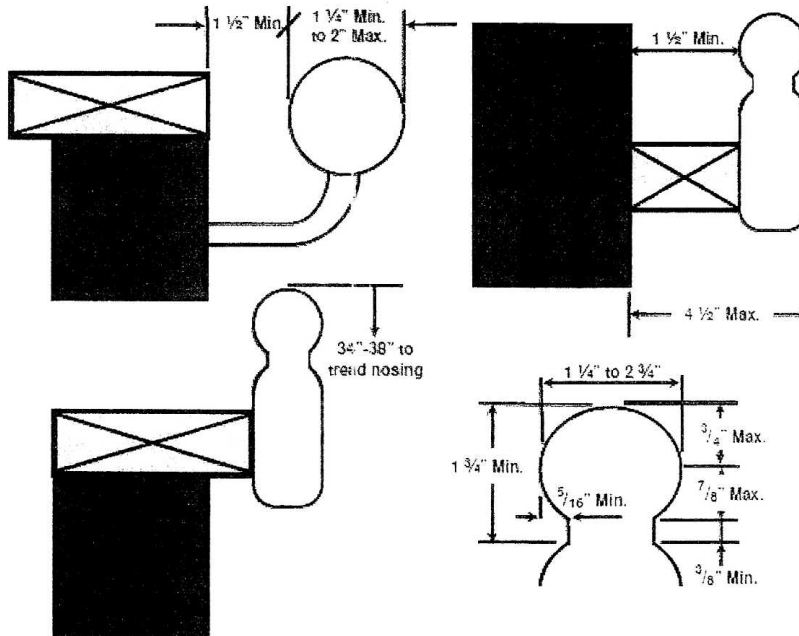

Guards and handrails must be provided as shown on the following illustrations. Guards must continue down stairs where the stair is more than 30 inches above grade. The height of guards on stairs must be 34 inches minimum.

Handrails must be provided on at least one side when there are four or more risers. Handrails must have returns on each end or terminate in a newel post. Other handrail shapes having an equivalent gripping shape may be used with prior approval of the Building Department.

Handrails must be continuous for the entire length of the stairs and may not be interrupted by newel posts except at landings.

Hand rails and guards must be designed to support a 200 lb load applied in any direction at any point along the top of the guard or rail. The bottoms of the stringers should rest on a sound foundation such as a gravel bed, a concrete pad, pavers, or similar.

HANDRAIL RETURNS:

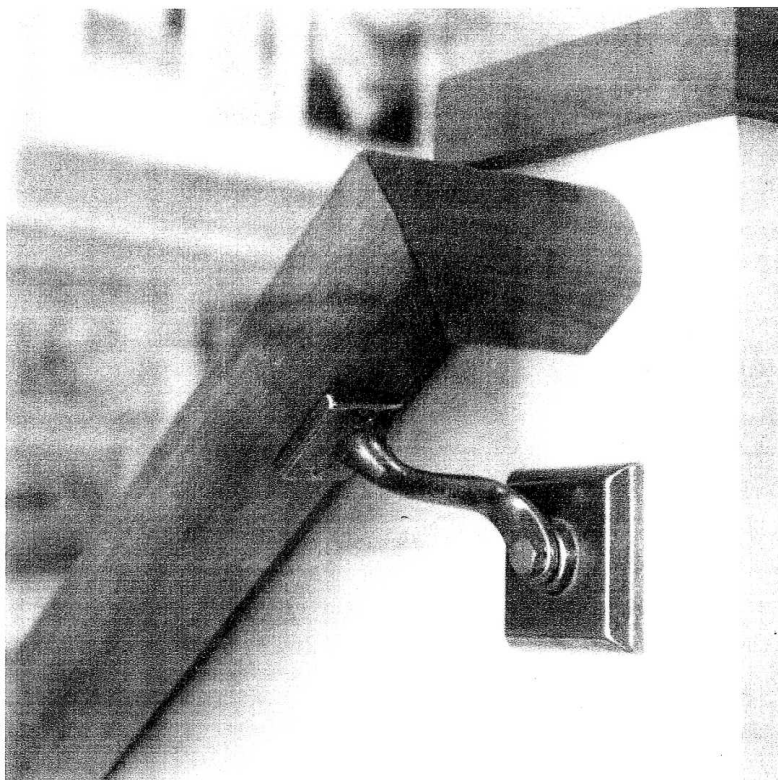

Metro West Inspection
 New deck at "Bay" location

3-25-2015

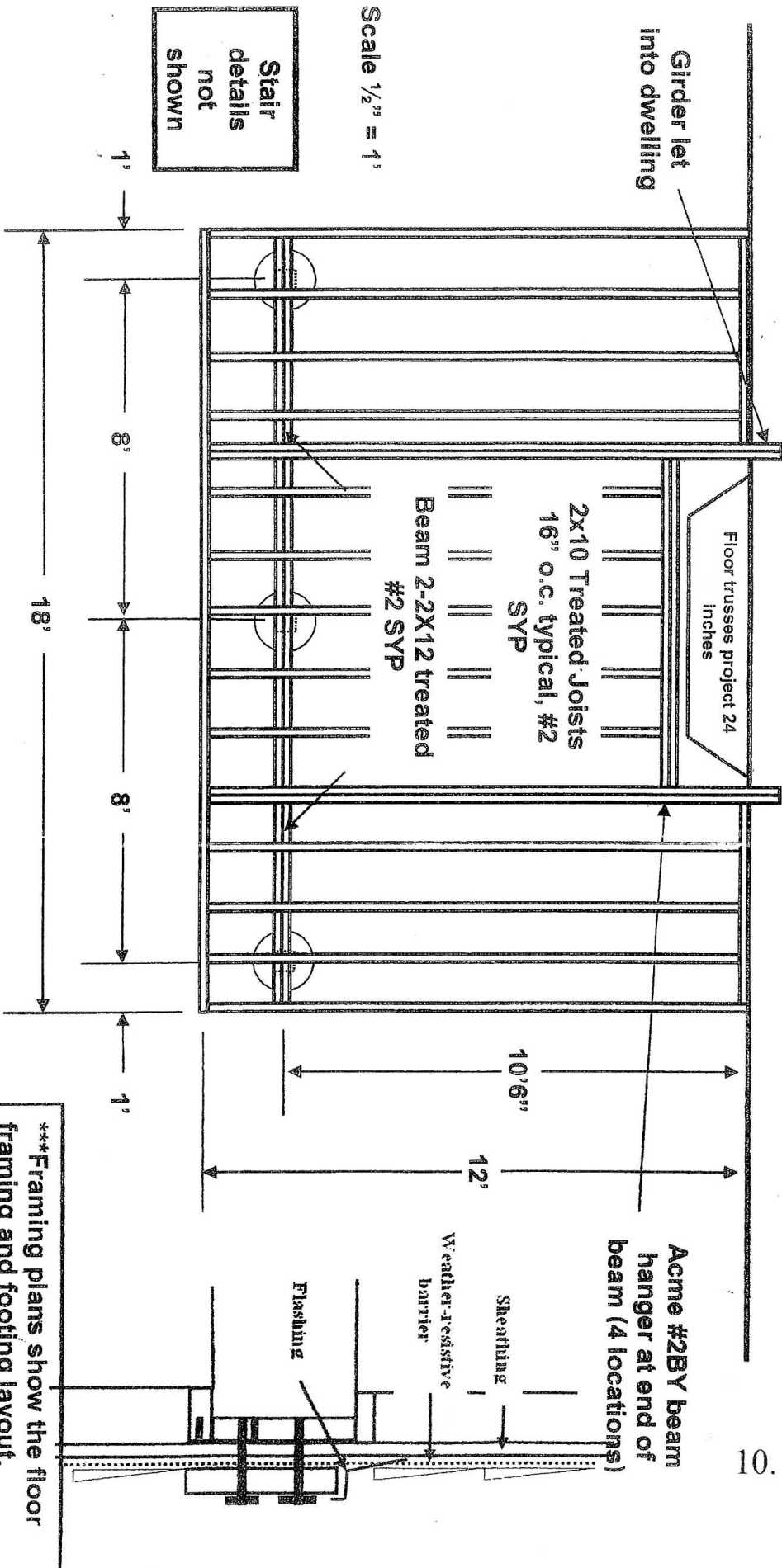

Note about House cantilevers: Occasionally home designs include a cantilever of the floor system at the patio door. Decks may not be attached to the cantilevered joists unless the house floor framing is engineered for the deck loads.

***Framing plans show the floor framing and footing layout, enable checks on spans and sizing of beams and joists, validation of footing sizes, and the ledger design. ***

WARNING: THIS IS AN ILLUSTRATION ONLY. IT IS INTENDED TO SHOW SOME OF THE INFORMATION THAT SHOULD BE INCLUDED ON YOUR DECK PLANS. IT IS NOT INTENDED TO SHOW COMPLIANCE WITH ALL CODES THAT MAY APPLY. CHANGES IN THE HEIGHT AND SIZE OF A DECK WILL CAUSE VARIATIONS IN CODE REQUIREMENTS.

SUPPLEMENT to DECK Permit Application Worksheet
(must be included when applying for permit)

The following information is required to be included with a Deck permit application.

1. Footing Diameter: _____ Depth _____
2. Size of posts: _____
3. Size of beams: _____
4. Cantilever on beams: _____
5. Size of joists: _____ Spacing _____
6. Cantilever on joists: _____
7. Size of floor boards: _____ Type _____
8. Species of lumber (please check one): Southern Yellow Pine Ponderosa Pine
 Spruce Pine Fir Hemlock Fir Douglas Fir Cedar Composite Unknown
If using composite decking materials please indicate the manufacture. _____
9. Height of deck off ground: _____
10. Height of guardrail: _____
11. Spacing of Spindles: _____
12. Height of Handrail: _____
13. Size of deck: _____
14. Distance to property lines: _____
 - a. Side 1: _____
 - b. Side 2: _____
 - c. Rear: _____
 - d. Other: _____

HOUSE

UNLESS SPECIFICALLY
ENGINEERED, DECKS
CANNOT BE ATTACHED TO
CANTILEVER FLOORS

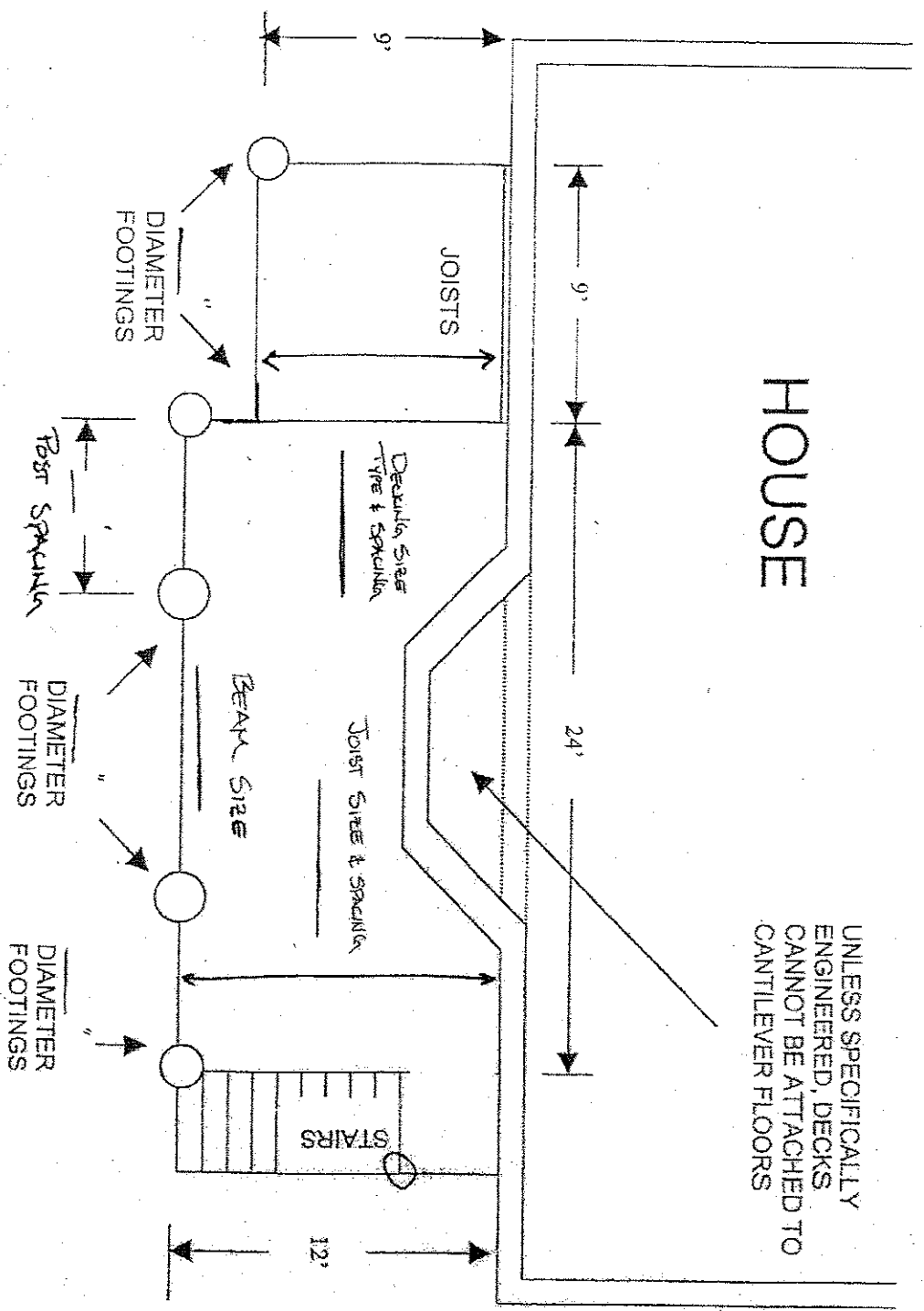

SAMPLE FLOOR PLAN

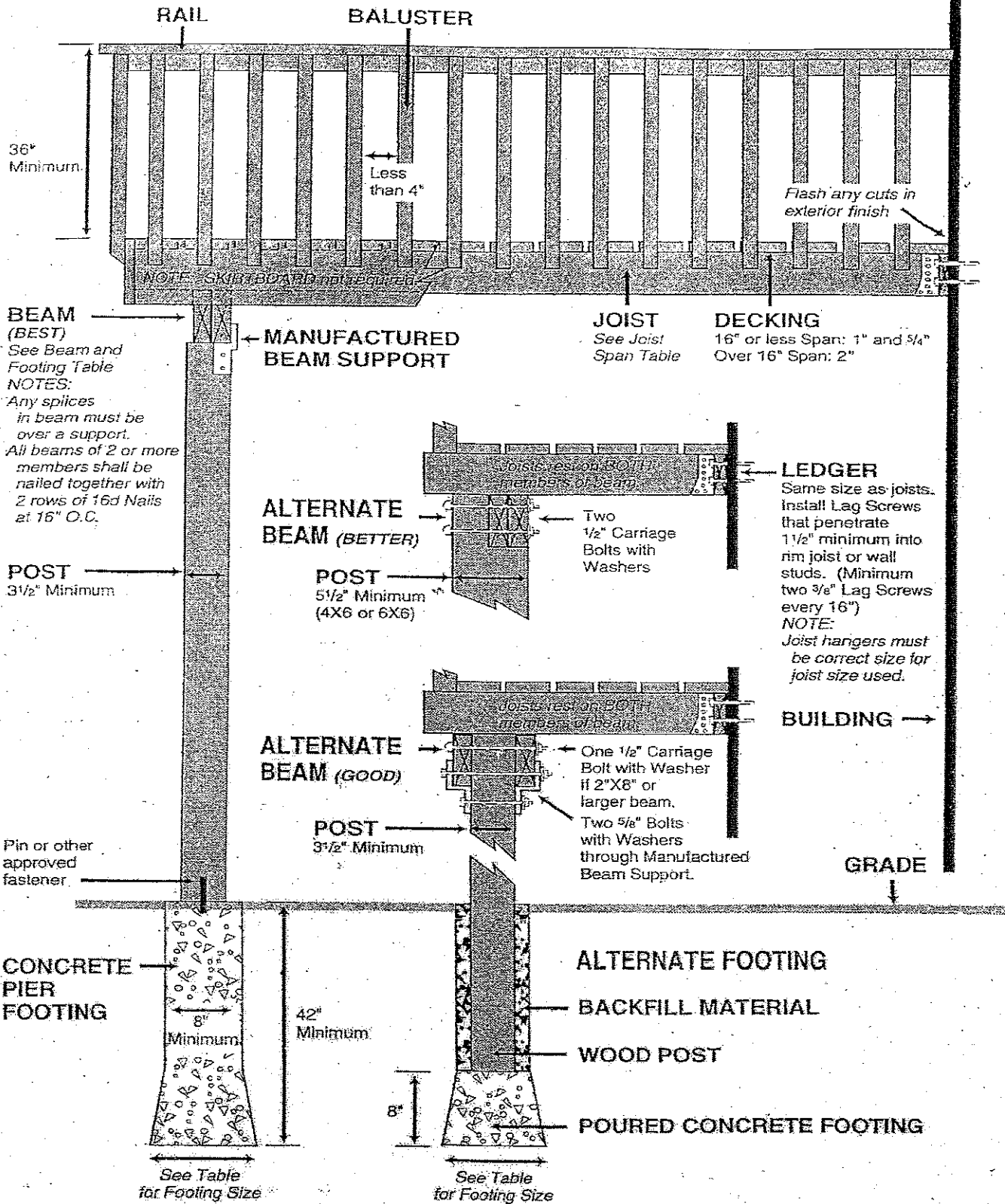

POST SPACING

JOIST LENGTH

TRAINED SOUTHERN YELLOW PINE

	6'	7'	8'	9'	10'	11'	12'	13'	14'	15'	16'
4'	JOIST SIZE	2 x 8 16" oc	2 x 6 16" oc	2 x 8 16" oc	2 x 8 16" oc	2 x 8 16" oc	2 x 8 12" oc	2 x 10 16" oc	2 x 10 16" oc	2 x 10 12" oc	2 x 12 16" oc
	BEAM SIZE	2 x 8 24" oc	2 x 8 24" oc	2 x 8 24" oc	2 x 10 24" oc	2 x 10 24" oc	2 x 10 16" oc	2 x 12 24" oc	2 x 10 16" oc	2 x 12 16" oc	2 x 12 16" oc
5'	JOIST SIZE	2 x 6 16" oc	2 x 6 16" oc	2 x 6 16" oc	2 x 8 16" oc	2 x 8 16" oc	2 x 8 12" oc	2 x 10 16" oc	2 x 10 16" oc	2 x 10 12" oc	2 x 12 16" oc
	BEAM SIZE	2 x 6 24" oc	2 x 8 24" oc	2 x 8 24" oc	2 x 10 24" oc	2 x 10 24" oc	2 x 10 16" oc	2 x 12 24" oc	2 x 10 16" oc	2 x 12 16" oc	2 x 12 16" oc
6'	JOIST SIZE	2 x 6 16" oc	2 x 6 16" oc	2 x 6 16" oc	2 x 8 16" oc	2 x 8 16" oc	2 x 8 12" oc	2 x 10 16" oc	2 x 10 16" oc	2 x 10 12" oc	2 x 12 16" oc
	BEAM SIZE	2 x 6 24" oc	2 x 8 24" oc	2 x 8 24" oc	2 x 10 24" oc	2 x 10 24" oc	2 x 10 16" oc	2 x 12 24" oc	2 x 10 16" oc	2 x 12 16" oc	2 x 12 16" oc
7'	JOIST SIZE	2 x 6 16" oc	2 x 6 16" oc	2 x 6 16" oc	2 x 8 16" oc	2 x 8 16" oc	2 x 8 12" oc	2 x 10 16" oc	2 x 10 16" oc	2 x 10 12" oc	2 x 12 16" oc
	BEAM SIZE	2 x 6 24" oc	2 x 8 24" oc	2 x 8 24" oc	2 x 10 24" oc	2 x 10 24" oc	2 x 10 16" oc	2 x 12 24" oc	2 x 10 16" oc	2 x 12 16" oc	2 x 12 16" oc
8'	JOIST SIZE	2 x 6 16" oc	2 x 6 16" oc	2 x 6 16" oc	2 x 8 16" oc	2 x 8 16" oc	2 x 8 12" oc	2 x 10 16" oc	2 x 10 16" oc	2 x 10 12" oc	2 x 12 16" oc
	BEAM SIZE	2 x 6 24" oc	2 x 8 24" oc	2 x 8 24" oc	2 x 10 24" oc	2 x 10 24" oc	2 x 10 16" oc	2 x 12 24" oc	2 x 10 16" oc	2 x 12 16" oc	2 x 12 16" oc
9'	JOIST SIZE	2 x 6 16" oc	2 x 6 16" oc	2 x 6 16" oc	2 x 8 16" oc	2 x 8 16" oc	2 x 8 12" oc	2 x 10 16" oc	2 x 10 16" oc	2 x 10 12" oc	2 x 12 16" oc
	BEAM SIZE	2 x 6 24" oc	2 x 8 24" oc	2 x 8 24" oc	2 x 10 24" oc	2 x 10 24" oc	2 x 10 16" oc	2 x 12 24" oc	2 x 10 16" oc	2 x 12 16" oc	2 x 12 16" oc
10'	JOIST SIZE	2 x 6 16" oc	2 x 6 16" oc	2 x 6 16" oc	2 x 8 16" oc	2 x 8 16" oc	2 x 8 12" oc	2 x 10 16" oc	2 x 10 16" oc	2 x 10 12" oc	2 x 12 16" oc
	BEAM SIZE	2 x 6 24" oc	2 x 8 24" oc	2 x 8 24" oc	2 x 10 24" oc	2 x 10 24" oc	2 x 10 16" oc	2 x 12 24" oc	2 x 10 16" oc	2 x 12 16" oc	2 x 12 16" oc

ACCEPTABLE HANDRAIL DETAILS



* Not less than 1 1/4 inch, or more than 2 5/8 inches.

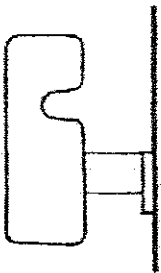

NOTE:
OTHER SHAPES MAY BE ACCEPTABLE
IF THEY PROVIDE AN
EQUIVALENT GRIPPING SERVICE.

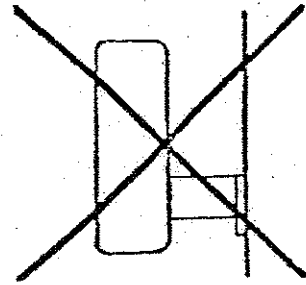

NOT
ACCEPTABLE

